

VCStack - Powerful Simplicity

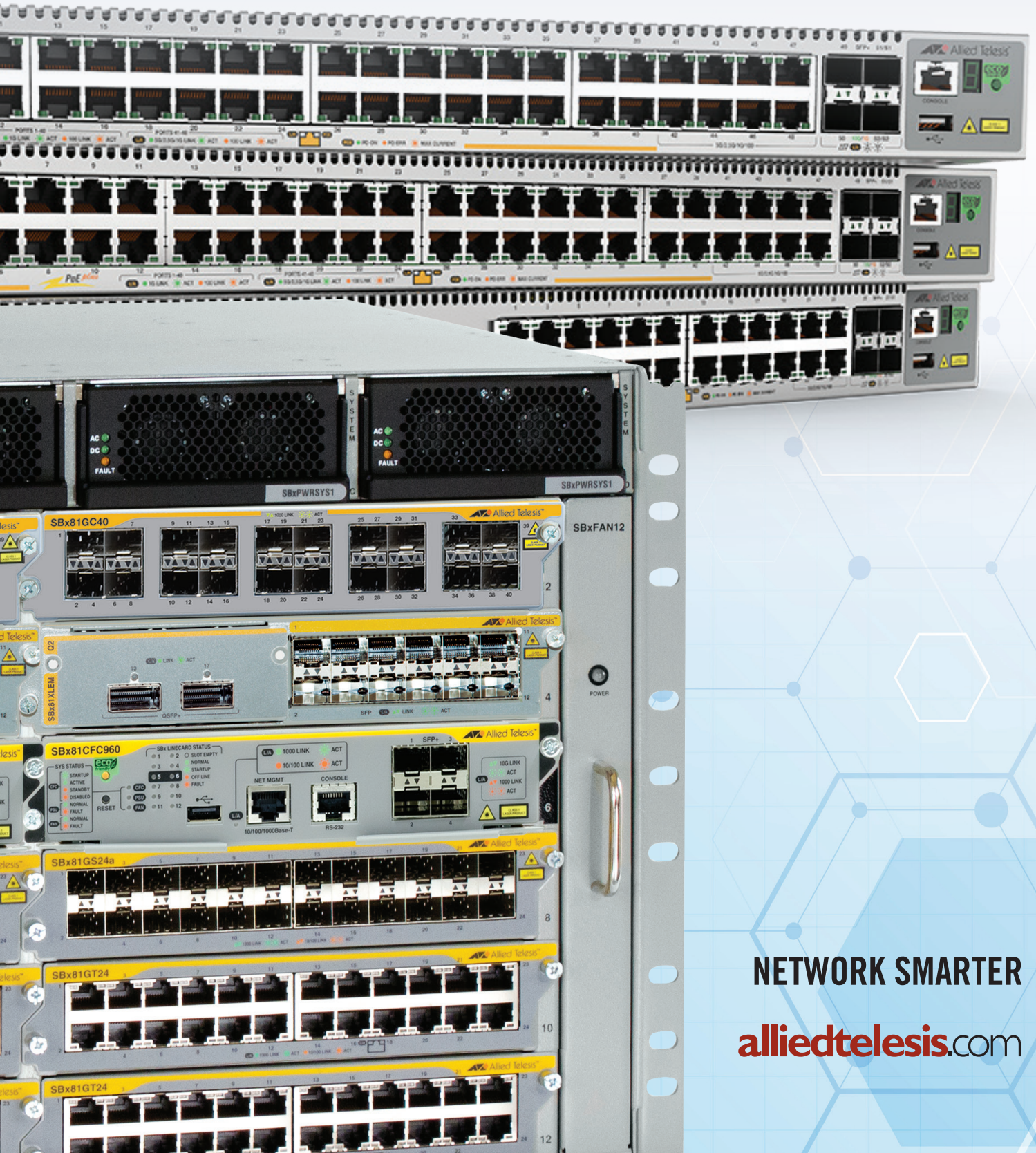

NETWORK SMARTER

alliedtelesis.com

Powerful Simplicity

Today's enterprises rely on Information Technology resources and applications for accessing business-critical information and for day-to-day work. A high availability infrastructure is no longer a luxury —maintaining resource availability and data security is now of paramount importance.

Productivity is adversely affected when any of the following occur:

- ▶ loss of access to the Internet
- ▶ loss of access to internal servers and intranet
- ▶ loss of IP telephony services
- ▶ loss of customer access to public servers

It is vital, even for a small enterprise, to keep high availability considerations at the center of network design. The availability of network resources is maximized with an Allied Telesis Virtual Chassis Stacking (VCStack™) solution, providing continuous and immediate access to information when required.

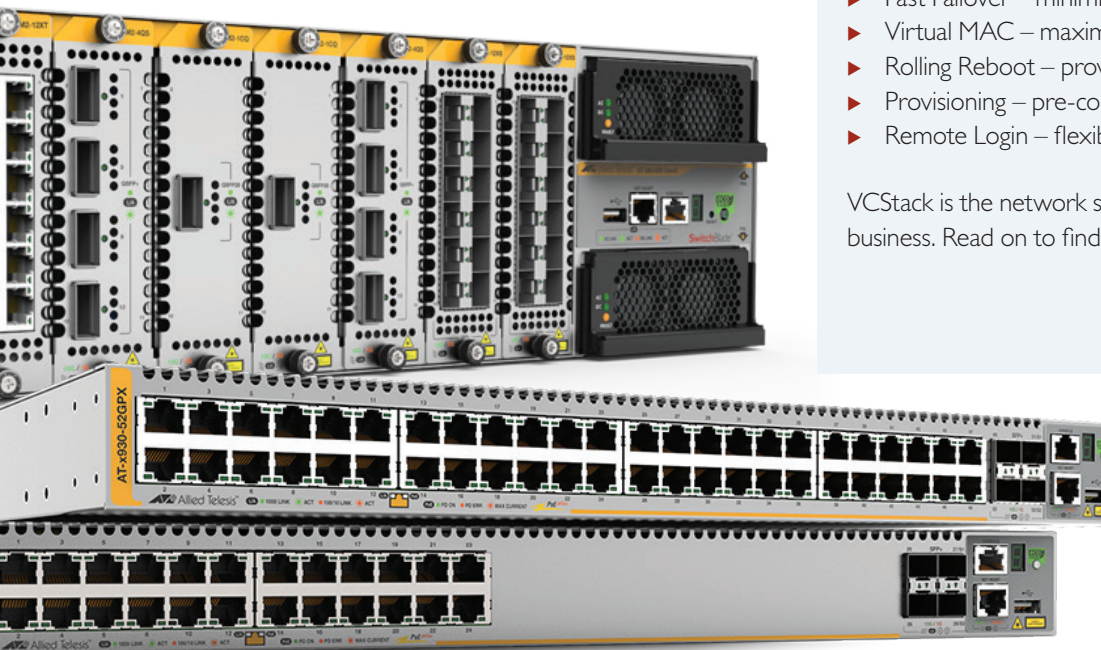

VCStack™

VCStack PLUS™

VCStack™ LD

VCStack

VCStack enables a truly resilient network with simplified management, as multiple devices operate as a single virtual chassis. In normal operation, all bandwidth is available all the time. If a link or device fails, the network remains operational with remaining resources fully utilized.

VCStack Plus

The power of VCStack is available on the SwitchBlade x8100 Series intelligent chassis switches. Stacking two chassis provides a solution with quad resiliency - perfect for the larger enterprise business or campus network.

VCStack-LD

As well as connecting collocated switches, a VCStack can be formed over long distance fiber links for a distributed network core, or an automated disaster recovery solution for business data.

Advanced Features

As well as enabling a resilient network with simplified management, VCStack also provides advanced features such as:

- ▶ Fast Failover – minimizes network downtime
- ▶ Virtual MAC – maximizes network connectivity
- ▶ Rolling Reboot – provides continuity of service
- ▶ Provisioning – pre-configure network devices
- ▶ Remote Login – flexible management of devices

VCStack is the network solution for today's enterprise business. Read on to find out more.

The VCStack Solution

VCStack™

The Solution

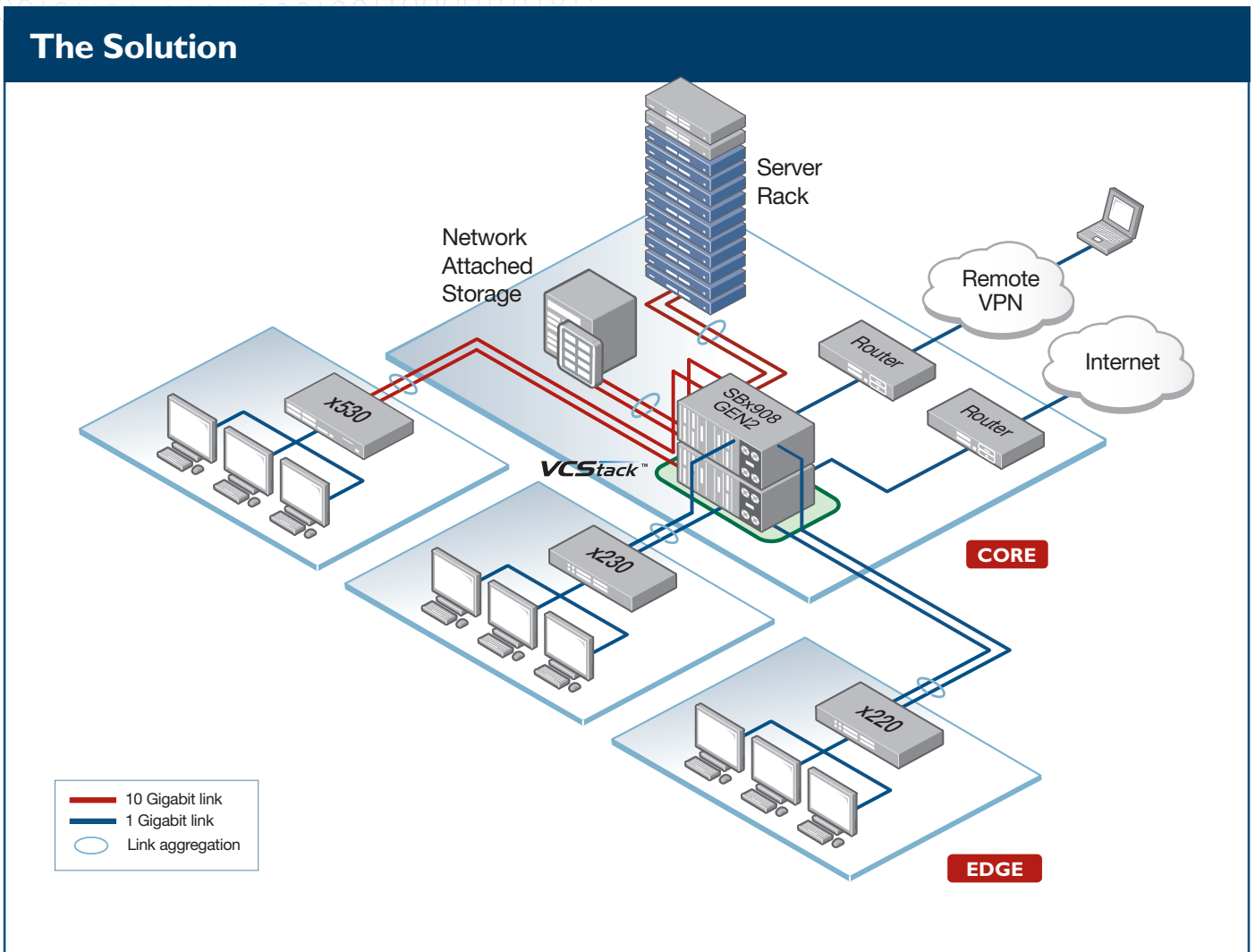

Network Resiliency

Prior to the advent of VCStack, high availability in enterprise networks was achieved by provisioning redundant links (with STP) and redundant routers (with VRRP). In normal operation, bandwidth and routing power would sit idle in the network.

With VCStack, Allied Telesis now provides a truly resilient network. In normal operation, all bandwidth and all routing power in the network are fully available for use all the time. If a link or device fails, some of the bandwidth or forwarding power will be lost, but the network will still be fully operational and all remaining resources will continue to be fully utilized.

Using VCStack at the core of your network allows multiple switches to appear as a single virtual chassis. This virtual chassis acts as a single switch, simplifying management.

The above diagram shows link aggregation between the core VCStack and edge switches. With link aggregation across ports on different virtual chassis members, there is no perceptible disruption in the case of a link failure, and the full bandwidth of the network is available. Link aggregation is also used to connect network resources, such as servers, across the virtual chassis members. This ensures device and path resiliency.

Virtualization of the network core ensures access to information when you need it, and this versatile solution can scale from meeting the needs of the small business right up to the larger enterprise.

VCStack Plus

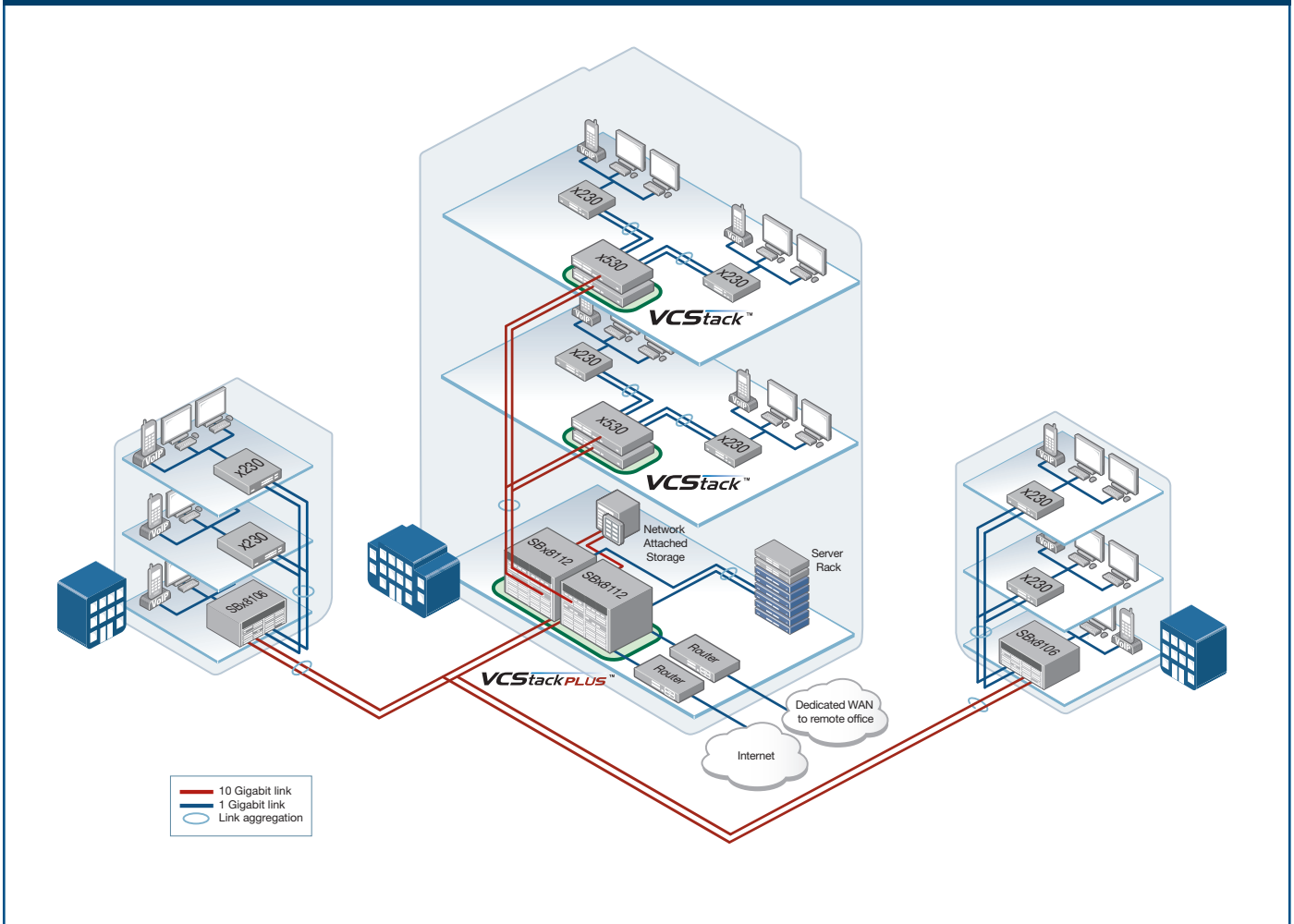

Complete network core resiliency

Allied Telesis VCStack technology is now available on our SwitchBlade x8100 Series chassis switches for a powerful network core solution with quad resiliency. Two SwitchBlade x8112 chassis with dual CFC960 control cards combine to form a single virtual unit with VCStack Plus, with the simplicity of managing just one device.

Link aggregation across the two chassis to servers, network storage, and distribution switches leaves no single point of failure in this high performing network core, ensuring device and path resiliency. Each individual chassis has PSU redundancy to ensure maximum uptime. Hot-swappable PSUs, fan tray, control and line cards allow for system maintenance and reconfiguration with no network interruption.

Real-time applications like VoIP and streaming video are assured premium service on the network, as near hitless failover between the dual control cards on each SwitchBlade x8112 means there is no perceptible disruption in the case of a problem. Even if a whole chassis is powered down, access to online resources is retained without disruption.

With the benefits of high availability, increased capacity and ease of management, VCStack Plus makes large networks reliable and simple.

Long Distance Stacking

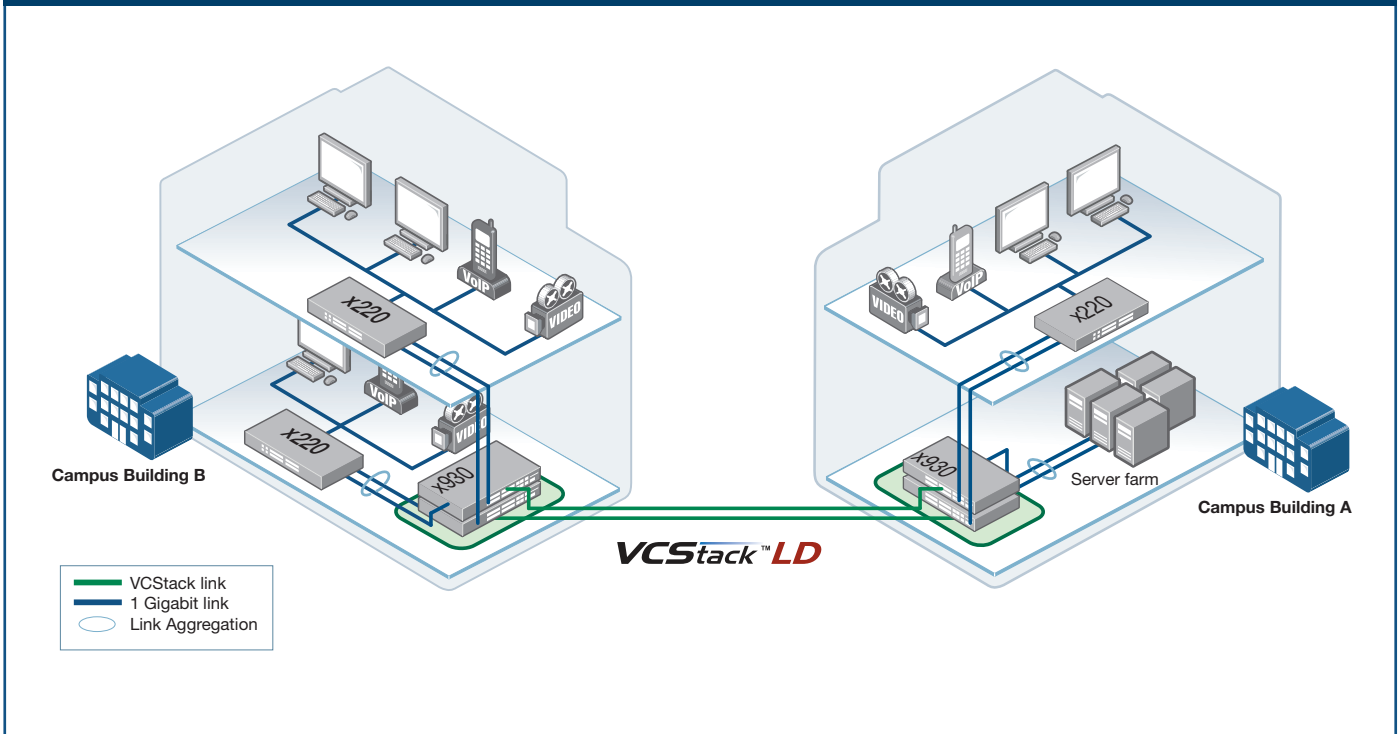

Distributed network core

Long distance stacking enables the VCStack solution to provide a distributed network core. The increased distance provided by fiber stacking connectivity means that members of the virtual chassis do not have to be collocated, but can be kilometers apart.

All of the benefits and powerful features of VCStack remain exactly the same — Allied Telesis long distance stacking provides a genuine distributed virtual network core.

The diagram shown here illustrates a campus where the VCStack network core is distributed across two separate buildings. By having two stack members in each location, the benefits of using link aggregation between the core and edge switches remain. The complete distributed virtual chassis provides a solution with no single point of failure, and a single management entity.

The powerful VCStack solution offers uninterrupted network access and high availability of critical resources, and yet is very simple to manage with almost plug-and-play configuration. This provides an ideal core for a data mirroring solution, where the server farm is duplicated across two sites for disaster recovery purposes.

Whether your virtual chassis is located in the same equipment rack, or distributed across the campus or the city, VCStack provides resiliency, scalability and ease of management.

VCStack Benefits

VCStack provides a highly available solution for uninterrupted network access, providing powerful management options while remaining simple to configure.

High Availability

Ensuring the availability of critical data and online resources is a major consideration for businesses today. The power of the VCStack solution is in the removal of any single point of failure in the network. This, along with the VCStack's full use of the bandwidth available in the network, creates a powerful solution. The following additional features serve to maximize data and resource availability.

Link Aggregation across stack members provides bandwidth and resiliency

Aggregated links from access switches to the VCStack can terminate on different stack members. If a link in the aggregation is removed or fails, there is little network disruption. The VCStack reacts almost instantly when an aggregated link fails, and the data forwarding process adapts to the loss of the link with almost no packet loss.

Virtual MAC maximizes network connectivity

When a VCStack is central to network design, this virtual chassis uses a virtual MAC address for communication with other devices. As this single virtual MAC address is used for the complete VCStack, there is no change of MAC address if a new stack member is required to become master. In conjunction with Fast Failover, this ensures maximum continuity of network service, as there is no need for other devices in the network to learn a new MAC address into their MAC or ARP tables.

Virtual MAC

A single virtual MAC address for the VCStack ensures maximum network connectivity no matter which switch is acting as Master.

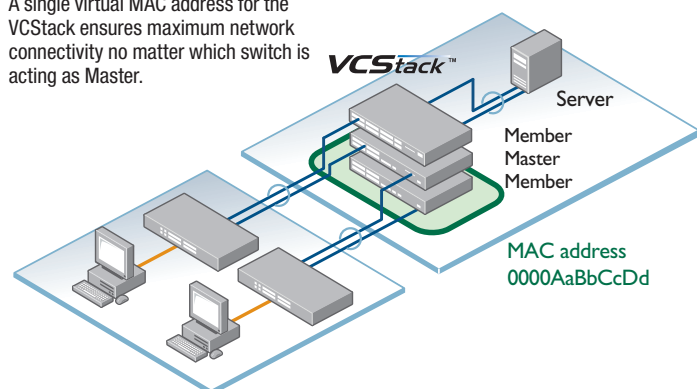

Resiliency Link provides intelligent recovery options

The dedicated stacking link is backed up by a further resiliency link. If the stacking link fails, communications between the stack members is maintained to enable graceful reconfiguration.

Rolling Reboot provides continuity of service

A major benefit of the VCStack solution is that it provides unit resiliency – if one unit in the stack goes down, the other members of the stack continue to forward data. It is desirable for this continuity of service to persist even when the stack is being rebooted. Rolling reboot maintains continuous service by rebooting the stack in a rolling sequence, so that there is at least one unit actively forwarding data at all times during the stack reboot sequence.

Rolling Reboot

First the VCStack Master switch is rebooted - connectivity is maintained via the Member switches

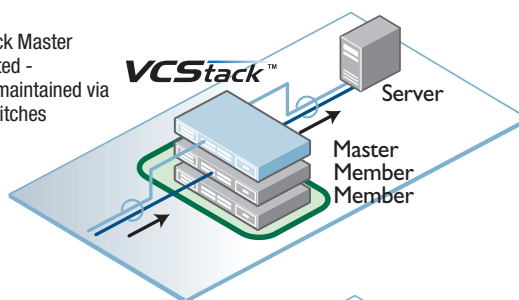

Once the Master is back online, the VCStack Member switches are rebooted

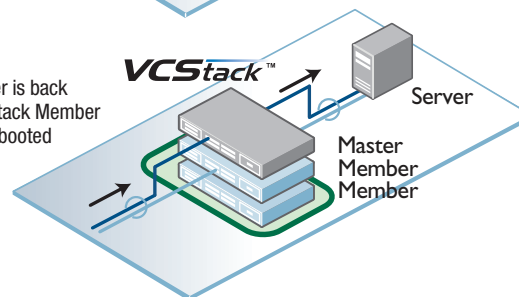

Fast Failover minimizes network downtime

Fast Failover provides for nearly uninterrupted network service. In a VCStack environment, one of the stack members acts as the master switch, and provides decision making for the virtual chassis. All of the other VCStack members are in active standby, also having learnt routing and forwarding information for the network to ensure that if the Master were to fail, another member is able to seamlessly assume control of the virtual chassis with absolutely minimal network downtime. Failover and recovery can be completed in as few as 3 seconds.

VCStack Benefits

Powerful Management

VCStack is very simple to configure with almost plug-and-play functionality for initial setup. This simplicity is maintained for network administrators, as the stack appears as a single virtual chassis for ongoing management and monitoring of performance, which can be done using the industry standard Command Line Interface (CLI), or an intuitive Graphical User Interface (GUI). The following features make powerful functionality available to the network administrator and support staff to further enhance the VCStack solution.

Remote Login allows flexible management of devices

Management of a VCStack is simplified for network administrators, as the stack acts as a single virtual chassis. Occasionally however, it can be desirable to login to a specific member of the stack. For example to manage feature licences per individual unit. Remote login facilitates this by allowing a user on the master switch to log into the CLI of another stack member. Configuration commands are still applied to all stack members, but 'show' commands, and commands that access the file system are executed locally. Consequently, the management interface into the VCStack provides the best of both worlds – the VCStack can be managed as a single unit, or as individual units, depending on which is more convenient for the task at hand.

Provisioning for pre-configuration of network devices

To add flexibility to the management of a VCStack, provisioning provides the ability to pre-configure (or configure 'offline') the switch ports of devices that are not currently physically present. This allows a network administrator to configure the ports of an additional VCStack member, or expansion module (XEM) before it is actually hot-swapped in. On the physical addition of the unit, the configuration is automatically applied, minimizing network disruption. The power of provisioning is further increased as a VCStack will retain interface configuration for a device that is removed, facilitating effortless hot-swap of units if required.

Configuration Synchronization automates file management

The configuration file that is loaded when the stack starts is called the startup-config. If the startup-config on the master switch is updated, the new startup-config is automatically saved to flash memory on all stack members. Similarly, it is automatically copied to any unit that subsequently joins the stack. This ensures that no updates will be lost on master failover or stack unit replacement.

Extensive Statistics support network management

To facilitate managing network resources effectively, network administrators require as much information as possible about traffic volume and resource use. Extensive statistics available from a VCStack virtual chassis provide a wealth of information about data throughput on a per-port, per-resource, or traffic type basis. This ensures the network administrator is fully informed and able to manage resources to best meet application and user requirements.

Providing exceptionally high network availability and simplicity of operation, backed up with powerful management options that can be used as required, VCStack is truly the solution for today's enterprise networks.

Provisioning

Switches can be added to the stack and pre-configured before they are physically present.

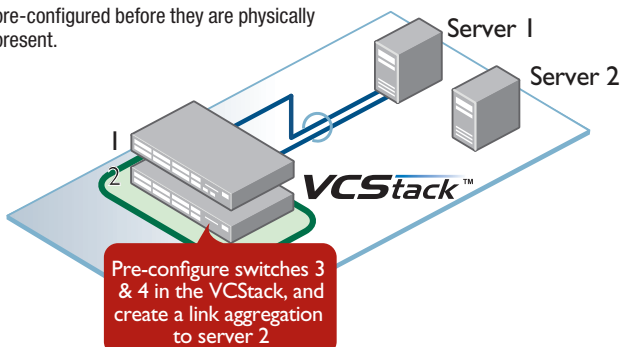

Switches 3 and 4 are automatically configured when they are connected.

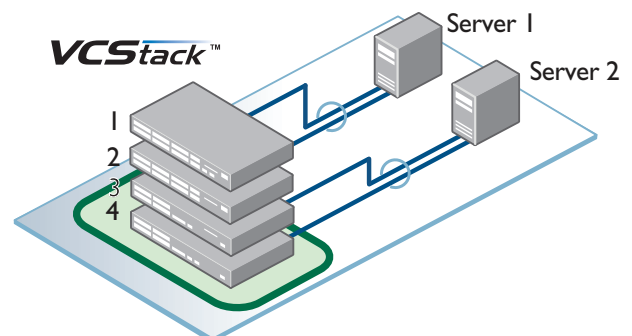

About Allied Telesis

For over 30 years, Allied Telesis has been delivering reliable, intelligent connectivity for everything from enterprise organizations to complex, critical infrastructure projects around the globe.

In a world moving toward Smart Cities and the Internet of Things, networks must evolve rapidly to meet new challenges. Allied Telesis smart technologies, such as Allied Telesis Autonomous Management Framework™ (AMF) and Enterprise SDN, ensure that network evolution can keep pace, and deliver efficient and secure solutions for people, organizations, and “things”—both now and into the future.

Allied Telesis is recognized for innovating the way in which services and applications are delivered and managed, resulting in increased value and lower operating costs.

Visit us online at alliedtelesis.com



NETWORK SMARTER

North America Headquarters | 19800 North Creek Parkway | Suite 100 | Bothell | WA 98011 | USA | T: +1 800 424 4284 | F: +1 425 481 3895

Asia-Pacific Headquarters | 11 Tai Seng Link | Singapore | 534182 | T: +65 6383 3832 | F: +65 6383 3830

EMEA & CSA Operations | Incheonweg 7 | 1437 EK Rozenburg | The Netherlands | T: +31 20 7950020 | F: +31 20 7950021

alliedtelesis.com

© 2020 Allied Telesis Inc. All rights reserved. Information in this document is subject to change without notice. All company names, logos, and product designs that are trademarks or registered trademarks are the property of their respective owners.
C618-31008-00 RevF